

SE

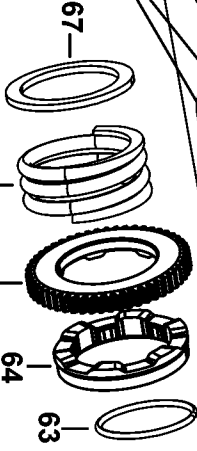

114

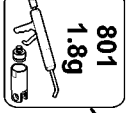
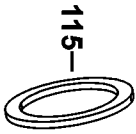
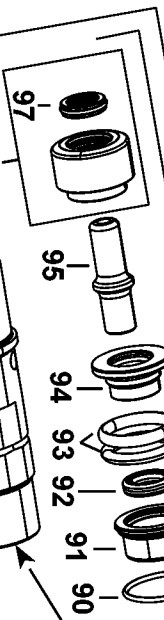

134

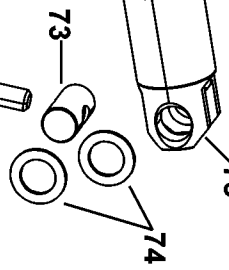
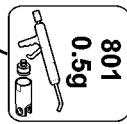
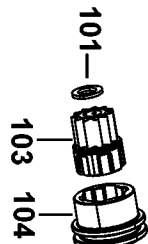
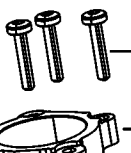
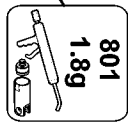
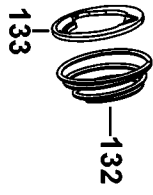
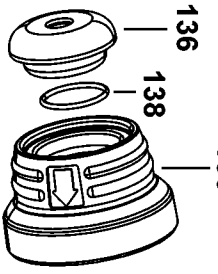

70

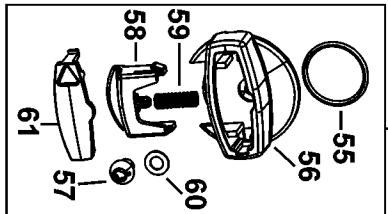
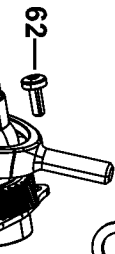
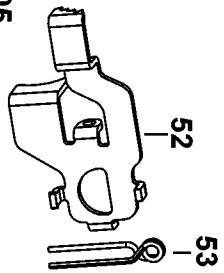
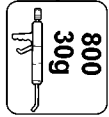
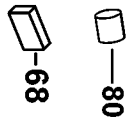
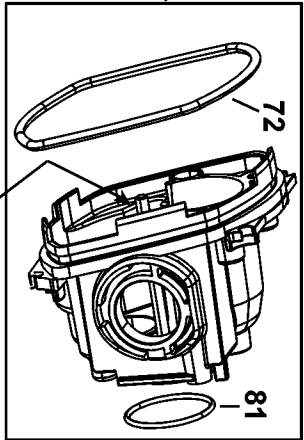

846

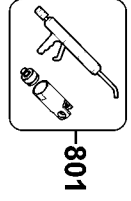
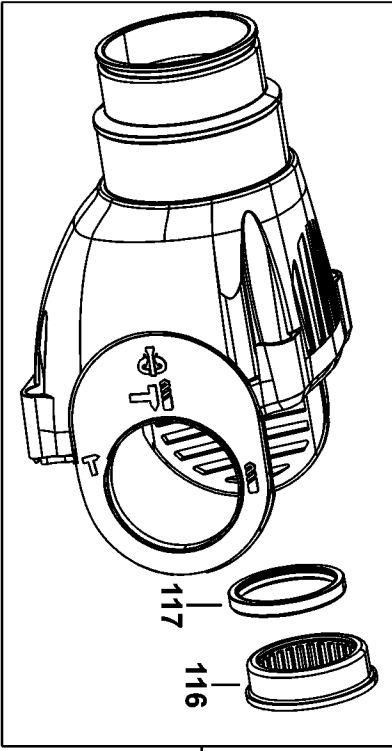
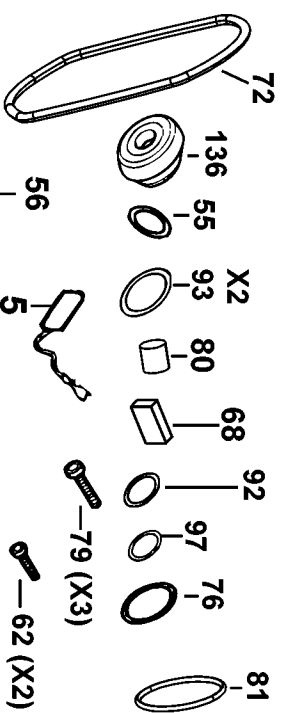

## Parts List for D25123K Type 10

Item Number	Part Number	Description	Qty Required
1	N081738	ARMATURE ASSEMBLY	1
2	N081741	FIELD	1
3	583748-05	SWITCH	1
4	N028620	BRUSH HOLDER ASSY	2
5	N081989	BRUSH,PAIR	1
7	584090-00	CORD PROTECTOR	1
8	330076-19	CORD SET	1
12	584304-00	LEAD	1
13	584304-10	LEADWIRE	1
14	584304-04	LEAD	1
15	584304-05	LEAD	1
16	584304-06	LEAD	1
17	584304-07	LEAD	1
18	930026-01	BUMPER	1
19	479818-00	LEVER	1
21	870052	BEARING COVER	1
22	324006-14	SCREW	2
23	326519-03	SCREW	4
25	330003-19	BEARING,BALL	1
29	584551-00	INSERT	1
31	577826-00	FAN BAFFLE	1
32	577810-03	FIELD CASE	1
32	583748-09	SWITCH	1
34	479817-00	HANDLE COVER	1
35	330065-06	SCREW	4
36	821070	CORD CLAMP	1
37	330065-09	SCREW	1

COPYRIGHT© 2005. All Rights Reserved.

Parts list, pricing, and availability subject to change. Please visit [www.dewaltservicenet.com](http://www.dewaltservicenet.com) for current parts information.

## Parts List for D25123K Type 10

Item Number	Part Number	Description	Qty Required
40	330065-25	SCREW	4
50	N081985	INTERSHAFT	1
52	N029727	PLATE	1
53	N042799	SPRING	1
55	N093371	LEVER ASSEMBLY	1
56	N093371	LEVER ASSEMBLY	1
57	330065-05	SCREW	1
58	N034136	TRIGGER	1
59	N074923	SPRING	1
60	1005811-00	SEAL	1
61	N034134	COVER	1
62	324006-14	SCREW	2
63	581836-00	SNAP RING	1
64	N081742	CLUTCH RING	1
65	N081984	GEAR	1
66	N029717	SPRING	1
67	577814-00	WASHER	1
68	N081515	FELT	1
70	N081983	HOUSING ASSY.	1
72	578229-00	SEAL	1
73	577801-00	BEARING BLOCK	1
74	N074454	SHIM WASHER	2
75	N081750	PISTON	1
76	579699-00	O-RING	1
77	N081751	RAM	1
78	N029731	BEARING BUSH	1
79	324006-15	SCREW	3

COPYRIGHT© 2005. All Rights Reserved.

Parts list, pricing, and availability subject to change. Please visit [www.dewaltservicenet.com](http://www.dewaltservicenet.com) for current parts information.

## Parts List for D25123K Type 10

Item Number	Part Number	Description	Qty Required
80	N038257	FILTER	1
81	N042496	O RING	1
90	N361759	SNAP RING	1
90	577793-00	CLIP	1
91	N082141	BUSHING	1
92	580990-00	O-RING	1
93	577135-00	O-RING	2
94	N082144	DAMPER	1
95	N082142	BEAT PIECE	1
96	N082145	BEARING & SEAL	1
97	577139-00	SEAL	1
100	N093350	LEVER KIT	1
101	1005844-00	WASHER	1
103	N029726	PINION BUSH	1
104	N029725	SHIFT COLLAR	1
105	000000-00	No Longer Available	1
110	N059509	WASHER	1
114	N386323	SPINDLE ASSEMBLY	1
115	577814-00	WASHER	1
116	N082143	NEEDLE BEARING	1
117	577812-00	SEAL	1
118	N081754	HOUSING ASSY.	1
121	330019-81	SCREW	4
132	871690	SPRING	1
133	578387-00	WASHER	1
134	583890-00	BALL	1
135	493965-00	TUBE	1

COPYRIGHT© 2005. All Rights Reserved.

Parts list, pricing, and availability subject to change. Please visit [www.dewaltservicenet.com](http://www.dewaltservicenet.com) for current parts information.

## Parts List for D25123K Type 10

Item Number	Part Number	Description	Qty Required
136	323489-00	CAP	1
138	579212-00	RING	1
160	1008956-00	SIDE HANDLE ASY	1
170	495699-00	DEPTH STOP	1
800	870889-02	GREASE	1
801	487130-04	GREASE	1
817	496620-00	LABEL	1
821	N074443	NAMEPLATE	1
830	N074584	ID LABEL	2
836	1003926-99	SERVICE TOOL	1
836	596005-99	SERVICE TOOL	1
836	1003924-99	SERVICE TOOL	1
836	1003925-99	SERVICE TOOL	1
846	N093352	SERVICE KIT	1
861	N328939	KIT BOX	1

COPYRIGHT© 2005. All Rights Reserved.

Parts list, pricing, and availability subject to change. Please visit [www.dewaltservicenet.com](http://www.dewaltservicenet.com) for current parts information.